

2023

Product Guide

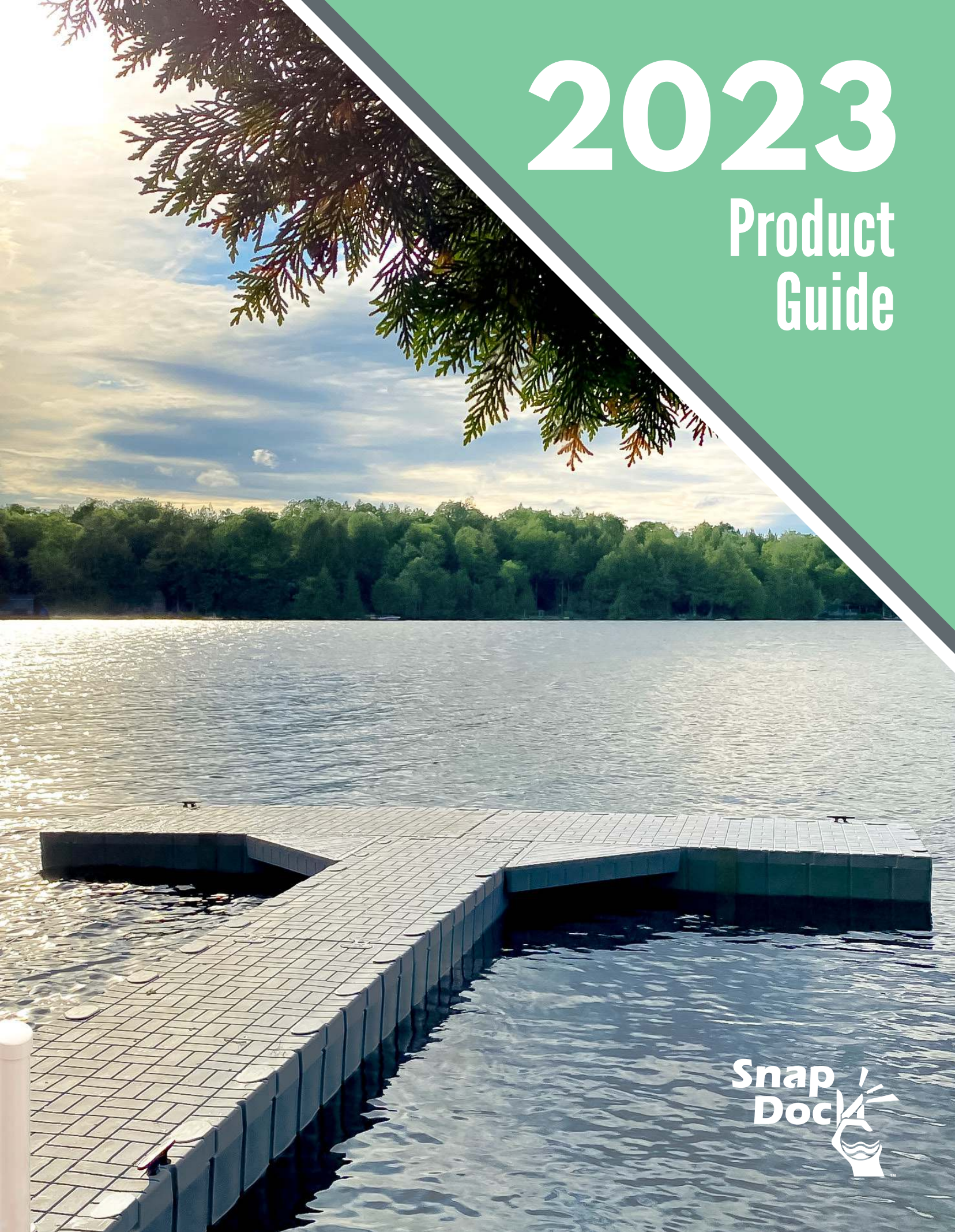

C Contents



6

Product Specifications

40" Dock Section 4060 Dock Section 60" Dock Section
80" Dock Section Snap Port

7

Dock Section Dimensions

40" Dock Section 4060 Dock Section 60" Dock Section
80" Dock Section Snap Port

12

Snap Port Installation Options

Specifications Attachment Options

13

Snap Port Accessories

Port Roller Long Set Port Roller Short Set
Port Cover Kit Port Coupler Set Pocket Fillers

14

Modular Gangways & Ramps

Accessories

16

Coupler System



17

Half Coupler Hardware Connectors

Center-To-Center Distance Between Pockets
Cleat Mounting Location

18

Anchoring

Hinge Kits Pipe Brackets Piling Bracket
Stand Off Bracket Deadweight Brackets Stiff Arm Bracket

24

Snap Dock Builder

Tutorial

26

Snap Port Configurations

Single Double Triple
40" Section Layout A 40" Section Layout B
40" Section Layout C 60" Section Layout D
60" Section Layout E 60" Section Layout F

29

40" Dock Section Configurations

" I " Layout " T " Layout
" L " layout " U " Layout

31

60" Dock Section Configurations

" I " Layout " T " Layout
" L " layout " U " Layout

33

40" & 60" Dock Section Configurations

" M " Layout " T " Layout

34

Port & Dock Section Configurations

" L " Layout " T " Layout
" M " Layout + Ports

36

Product Catalog





Our Story

Snap Dock's story began in 1982 when our parent company first patented a rotationally molded collapsible container, quickly becoming the standard for the automotive and manufacturing industries. The company later expanded into other rotational molded products that serve the industrial market. Along the way, we saw an unmet need for an industrial floating walkway system that could be rapidly deployed. In 2018, Snap Dock rolled out a polyethylene floating walkway into the industrial market. After finding success with that product, we began developing a recreational lineup according to the same core tenets of durability and ease-of-use, launched in 2021.

We look forward to continuing to expand our product selection of best-in-class floating docks and accessories.



The Snap Dock Advantage

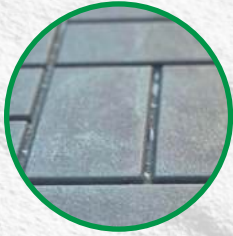

Attractive Non-Slip Surface

All dock sections feature an attractive non-slip surface that channels water and helps conceal dirt.

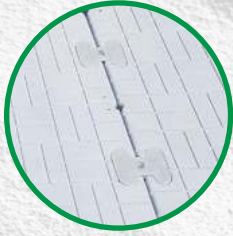

Seamless Color Integration

Snap Dock's coupler system matches the color of dock components.



Reinforced Surface Support

Snap Dock components are engineered to reduce deflection on the walking surface.



Unmatched Strength

Snap Dock's coupler system allows our docks to withstand significant wave action in rough water.



Industrial Grade Durability

All Snap Dock modular components are rotationally molded with industrial grade plastic (LLDPE) ensuring consistent performance in the most extreme weather conditions.



Customer Experience

We are committed to creating a family-like customer experience for distributors, dealers and end-users.



Product Specifications

40" Dock Section

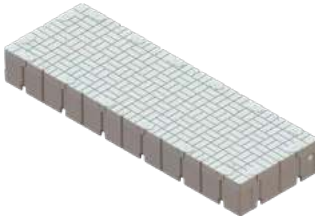

Buoyancy	2150 lbs./ 975 kgs.
Weight	178 lbs/ 81 kgs.
Dimensions	117" x 39"
SKU	SNAP120x40-GR

4060 Dock Section

Buoyancy	997 lbs./ 453 kgs.
Weight	119 lbs/ 54 kgs.
Dimensions	59" x 39"
SKU	SNAP60x40-GR



60" Dock Section

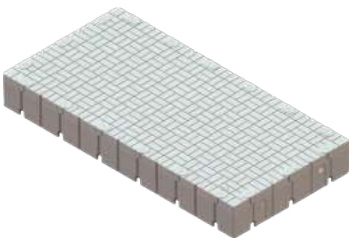

Buoyancy	3150 lbs./ 1440 kgs.
Weight	270 lbs/ 122 kgs.
Dimensions	117" x 59"
SKU	SNAP120x60-GR 2020

80" Dock Section

Buoyancy	4224 lbs./ 1916 kgs.
Weight	330 lbs/ 150 kgs.
Dimensions	117" x 79"
SKU	SNAP120x80-GR

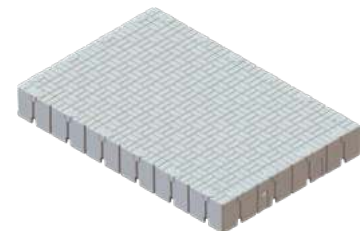

Snap Port



Buoyancy	1750 lbs./ 794 kgs.
Weight	370 lbs/ 168 kgs.
Dimensions	168" x 59"
SKU	SNAP PORT-ASSY-GR



40" Dock Dimensions

Top View Geometry

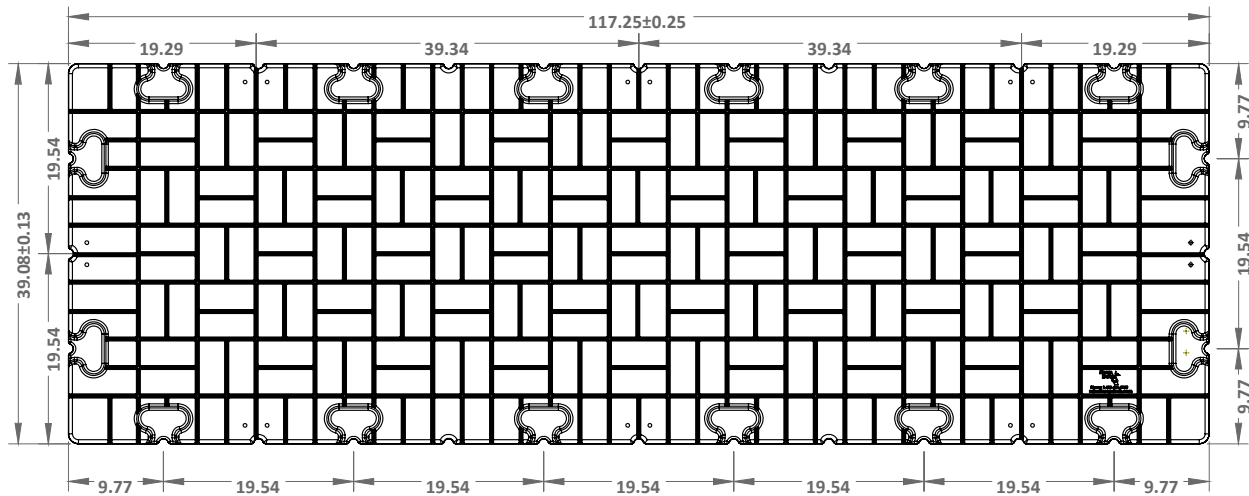

End View Geometry

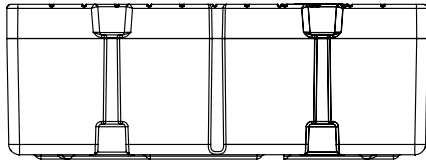

Side View Geometry

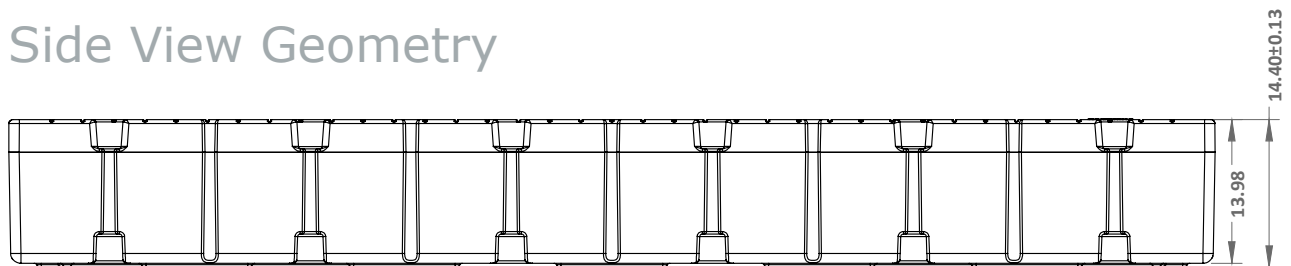

4060 Dock Dimensions

Top View Geometry

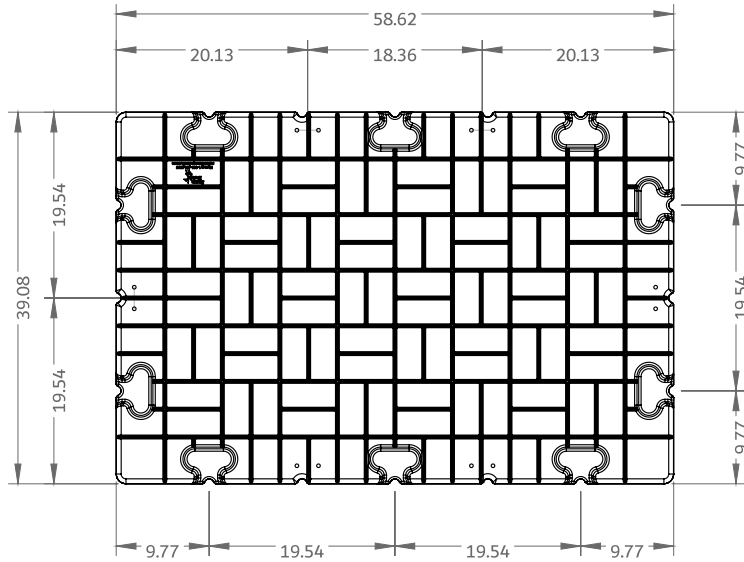

End View Geometry

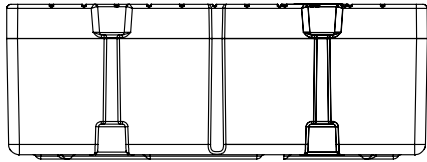

Side View Geometry

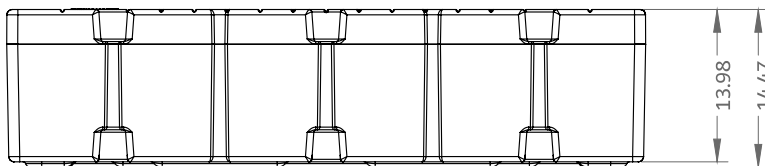

60" Dock Dimensions

Top View Geometry

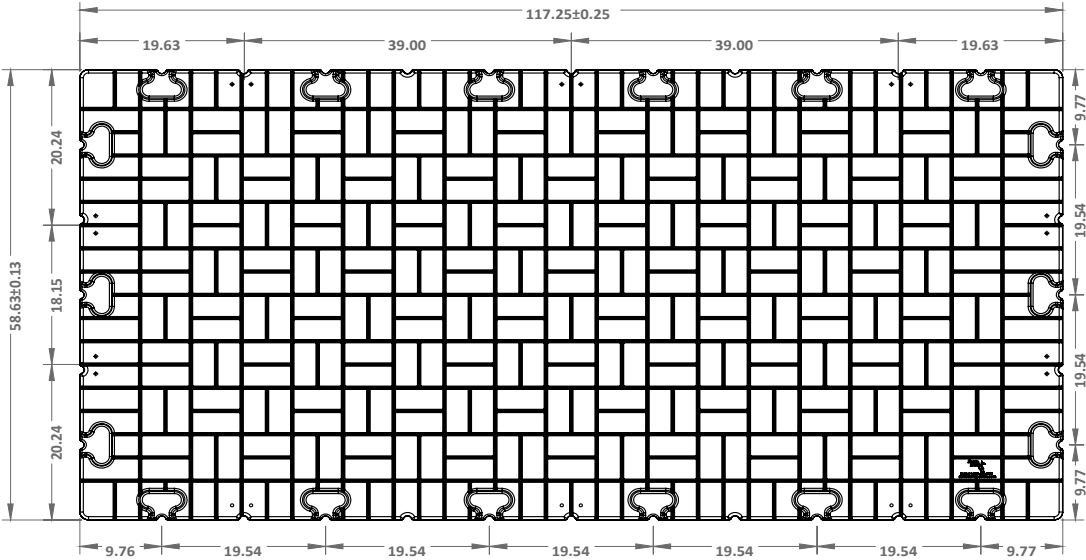

End View Geometry

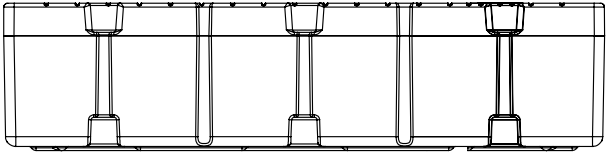

Side View Geometry

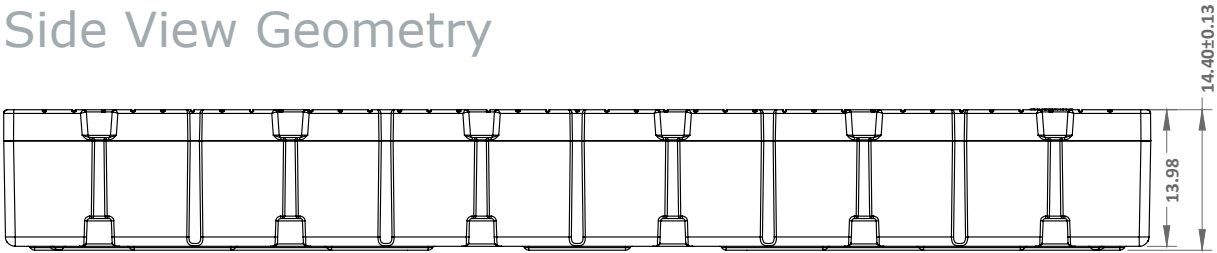

80" Dock Dimensions

Top View Geometry

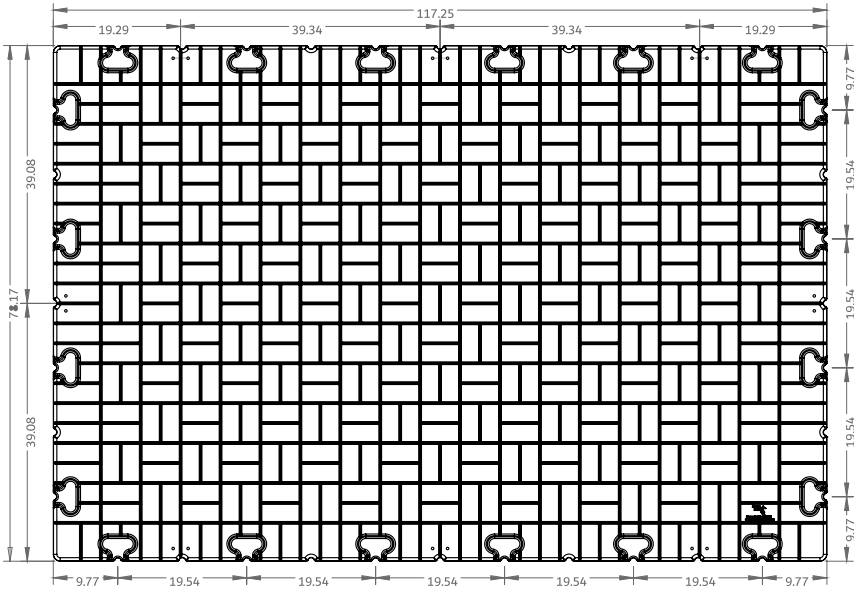

End View Geometry

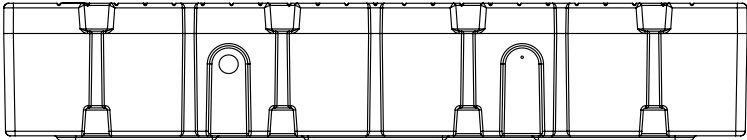

Side View Geometry

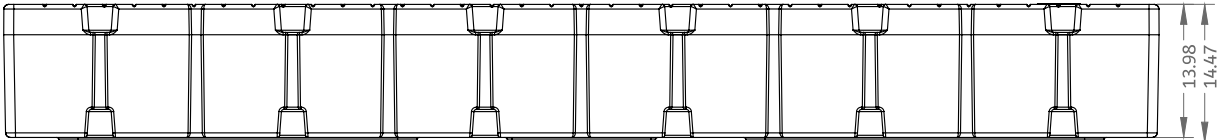

Snap Port Dimensions

Top View Geometry

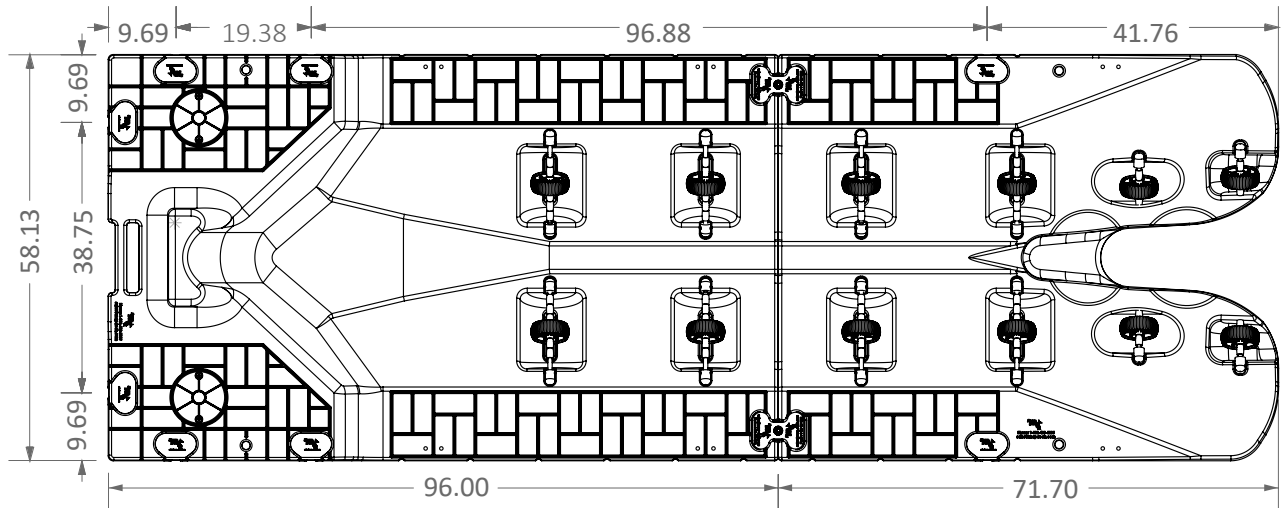

End View Geometry

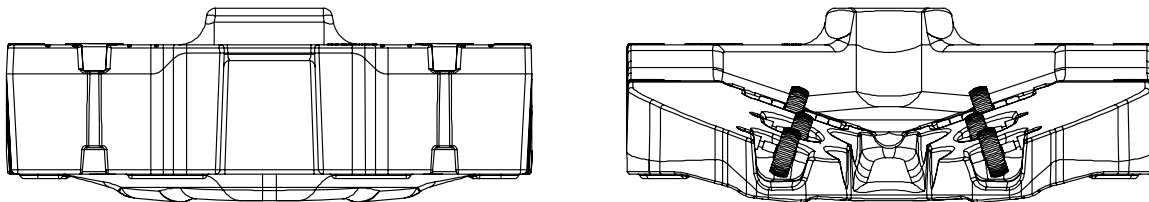

Side View Geometry

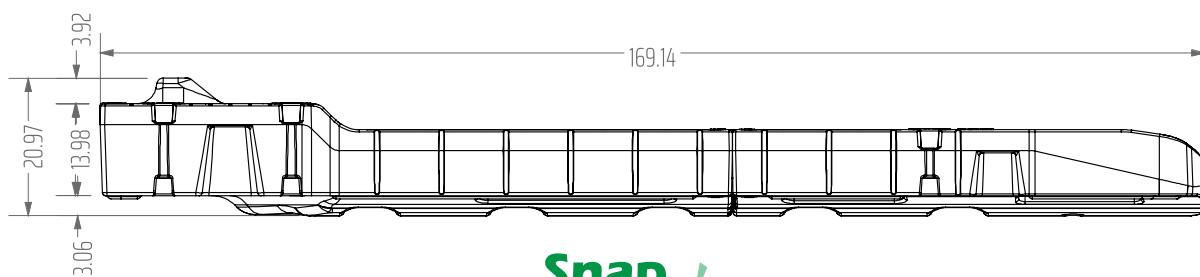

Snap Port

Installation Options

Poly Bracket

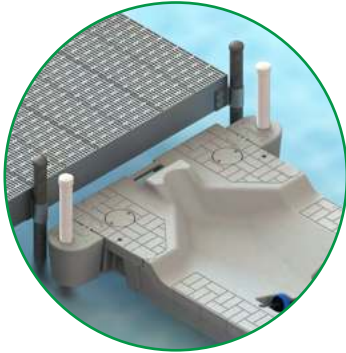

Hinge Adapter Kit

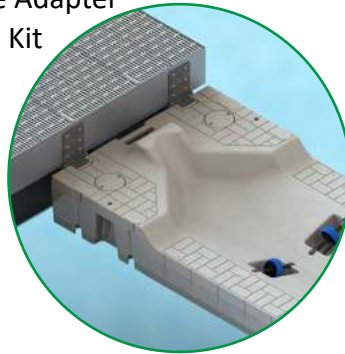

Coupler Set Attachment

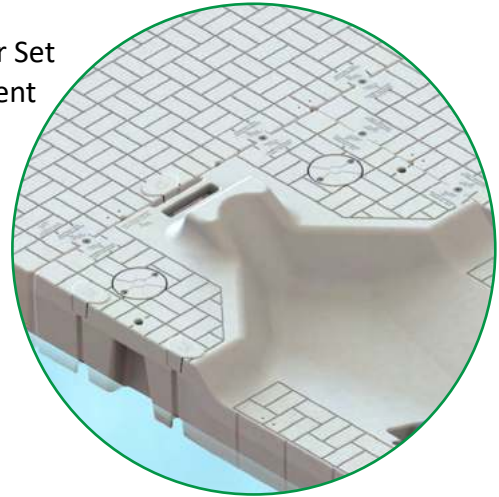

Stand off Bracket

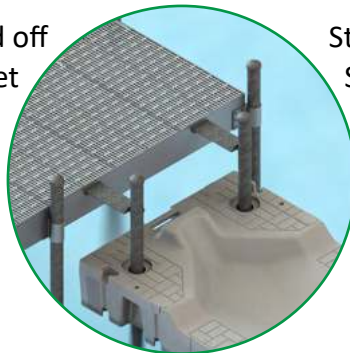

Stand Alone Snap Port

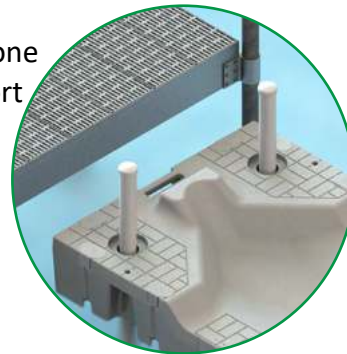

Specifications

Buoyancy	1750 lbs./ 794 kgs.
Weight	370 lbs/ 168 kgs.
Dimensions	168" x 59"
SKU	SNAP PORT-ASSY-GR

Attachment Options

Snap Dock System
Full Coupler Set.

Wood Docks
Adapter Hinge Kit, Stand Off Bracket, or Pipe Mounting with Poly Brackets.

Metal Docks
Adapter Hinge Kit, Stand Off Bracket, or Pipe Mounting with Poly Brackets.



Snap Port Accessories

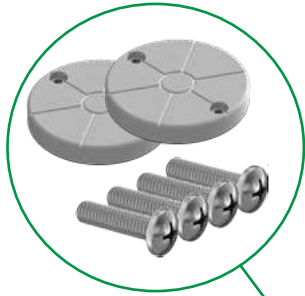

Port Cover:

SKU PORT COVER-ASSY-GR

Bill of Material
 2 PORT COVER-GR
 4 SCREW-COV



Port Coupler Set:

SKU CPLR-PORT-GR

Bill of Material
 2 CPLR-GR
 1 BOLT-S-GR
 1 NUT-GR
 1 DRIVETOOL

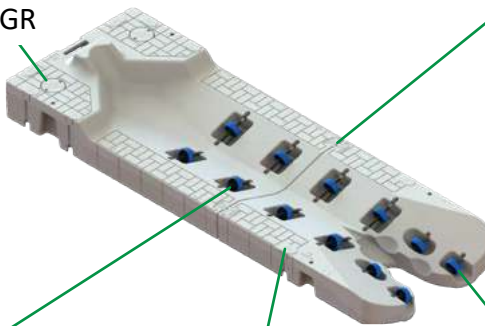

Roller Kit - Long Axle:

SKU ROLLER-L-ASSY

Bill of Material
 5 SPACER
 1 WHEEL
 2 PLUG
 1 SBAR-15



Pocket Filler:

SKU PFILL-GR

Bill of Material
 8 PFILL-GR



Roller Kit - Short Axle:

SKU ROLLER-S-ASSY

Bill of Material
 2 SPACER
 1 WHEEL
 1 PLUG
 1 SBAR-8



Modular Gangways & Ramps

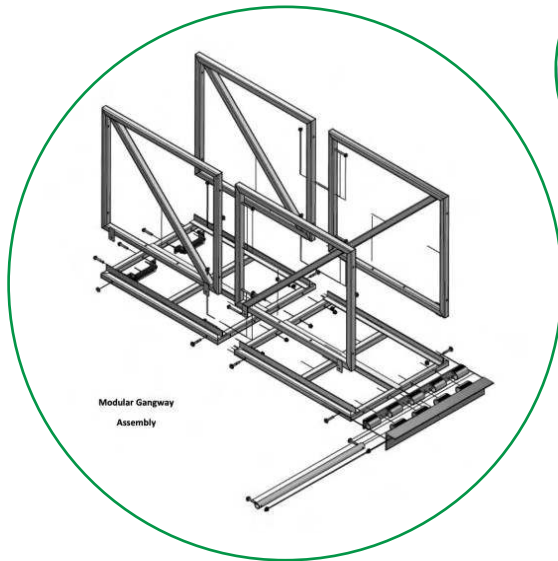

Modular Gangways
Dimensions
3' x 4'
4' x 4'

Description:

The residential gangway is framed out with a “box” pattern utilizing 1” x 2” square tubing. In addition, railings are welded onto the frame. Modular gangways can be combined up to 28’ lengths.

Residential Ramp
Dimensions
4' x 8'

Description:

The residential ramps is framed out with a “box” pattern utilizing 1” x 2” square tubing. Ramps exclude railings.

Note: All gangways & ramps come with composite decking unless aluminium is requested.



Gangway Accessories

Bolt-On Dock Hinge
Dimensions
2-Pocket, for 3ft
3-Pocket, for 3ft
3-Pocket, for 4ft

Abutment Hinge
Dimensions
3'
4'

Snap Dock Ladder
Product
Fixed Dock Ladder 5-step
Swivel Ladder 5-Rung
Dog Step Ladder

Roller Assembly
Dimensions
3'
4'

Kayak Rack
Product
Kayak Rack

Umbrella Sleeve
Product
Umbrella Sleeve

Transition Plate
Dimensions
3' x 4'
4' x 4'

Note: All gangways & ramps come with composite decking unless aluminium is requested.

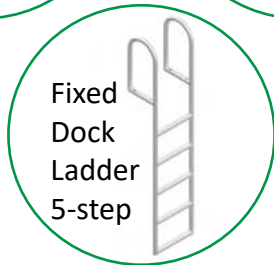
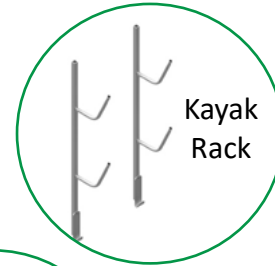
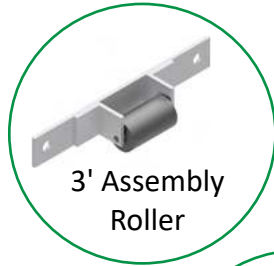
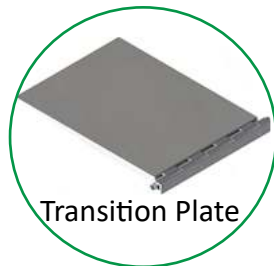
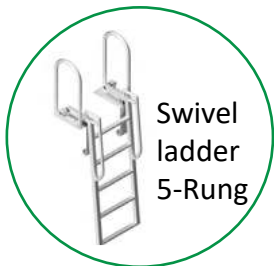

Coupler System

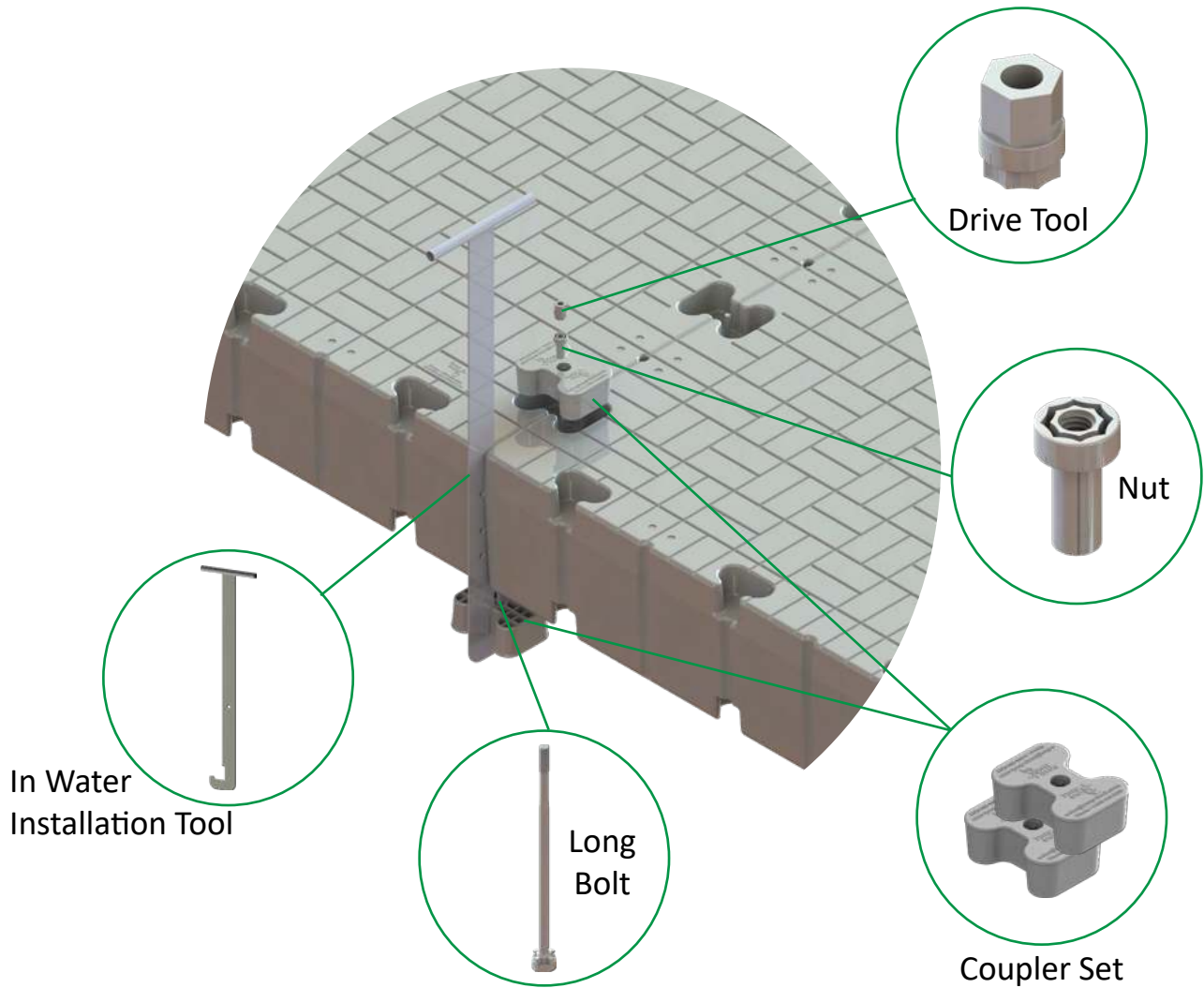

CPLR-SET-GR:

CPLR-GR	2
BOLT-L-GR	1
NUT-GR	1
DRIVETOOL	1

Individual SKUs & Prices:

SNAP INSTALL	
CPLR-GR	
BOLT-L-GR	
NUT-GR	
DRIVETOOL	



Half Couplers

Hardware Connectors

Center-to-Center Distance
Between Pockets

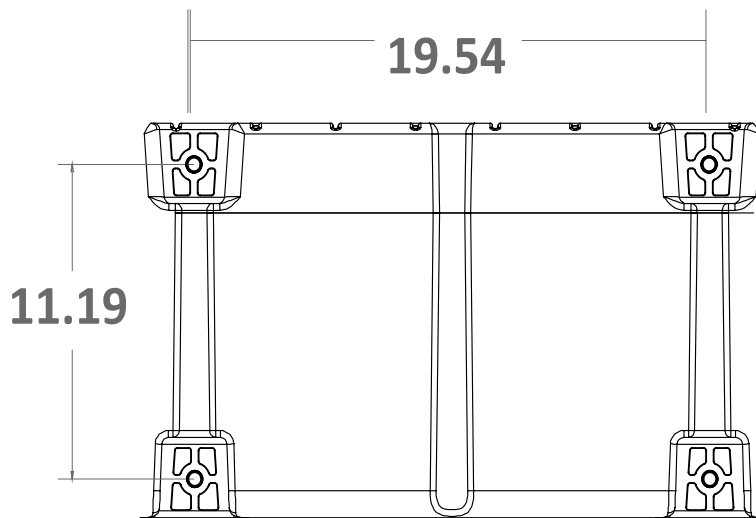

Male Half Coupler:

HALFCLPR-GR-ASSY	1
LOCKNUT-Z	1
WASHER	1

Note:
The molded bolt thread is 5/8"
for the male half coupler.

DETAIL B

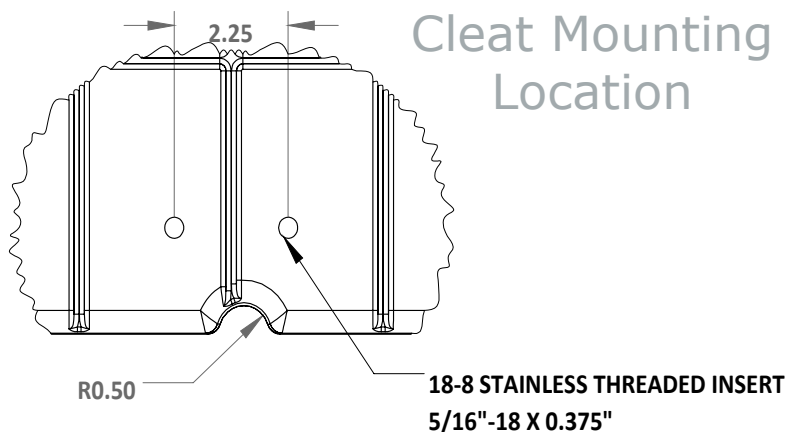

Female Half Coupler:

HALFCPLR-F-GR-ASSY	1
--------------------	---

Note:
5/8" hex bolt with stainless steel
washer needed.

Hardware Excluded.



Anchoring: Hinge Kits

Galvanized Hinge Kit:

HINGE-KIT-GALV-U:	
Dock Assembly Hinge	1
Dock Assembly Hinge Plate	2
McMaster #92141A033	1
McMaster #92198A758	1
McMaster #91831A137	1

Extended Galvanized Hinge Kit:

HINGE-KIT-GALV-XL:	
Dock Assembly Hinge	1
Dock Assembly Hinge Plate	2
McMaster #92141A033	1
McMaster #92198A758	1
McMaster #91831A137	1

Stainless Steel Hinge Kit:

HINGE-KIT-GALV-SS-U:	
Dock Assembly Hinge	1
Dock Assembly Hinge Plate	2
McMaster #92141A033	1
McMaster #92198A758	1
McMaster #91831A137	1

Purchasing of individual mcmaster parts visit the [McMaster Website](https://www.mcmaster.com).

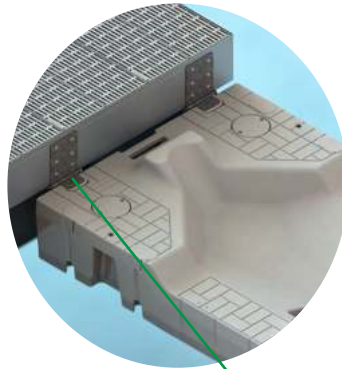

Galvanized & Stainless Steel Hinge Kits

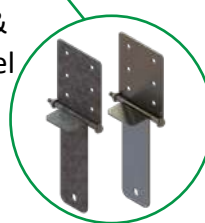

Extended Galvanized Hinge Kits

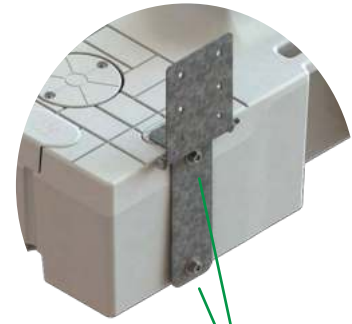
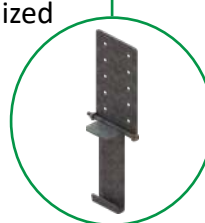

Male Half Coupler



Female Half Coupler



Male Half Coupler:

HALFCLPR-GR-ASSY	1
LOCKNUT-Z	1
WASHER	1

Note:
The molded bolt thread is 5/8" for the male half coupler.

Female Half Coupler:

HALFCLPR-F-GR-ASSY	1
--------------------	---

Note:
5/8" hex bolt with stainless steel washer needed.

Hardware Excluded.



Anchoring: Pipe Bracket



Standard Pipe
Bracket

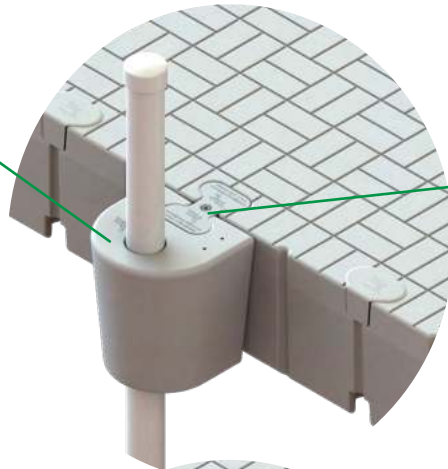

Coupler Set



Heavy Duty Pipe
Bracket

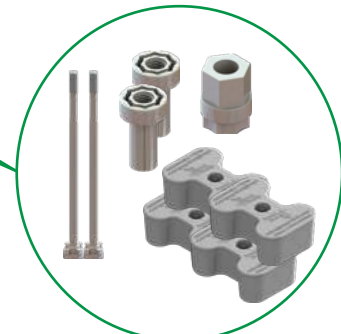
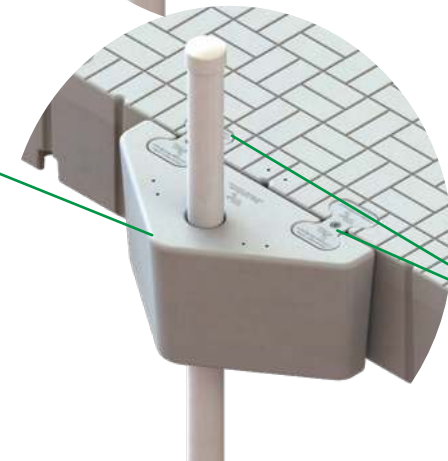

(2) Coupler Sets

Maximum Pipe Outside Diameter 3.5 Inches (3 Inch Nominal)

Standard Duty Pipe Bracket:

STD-BRKT-GR-ASSY	1
CPLR-SET-GR	1

Heavy Duty Pipe Bracket:

HD-BRKT-GR-ASSY	1
CPLR-SET-GR	2



Anchoring: Piling Bracket



(2) Coupler Sets



(4) Pocket Fillers



(1) Wear Ring &
Hardware

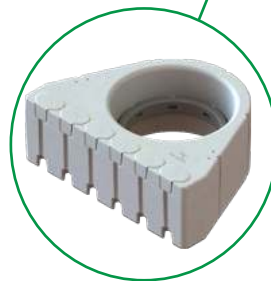

(1) Piling Bracket

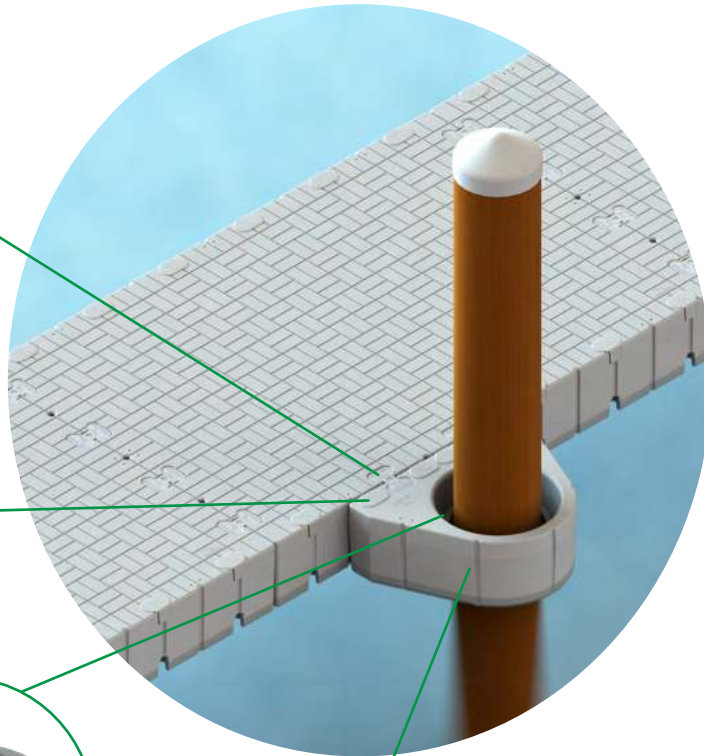

Piling Bracket:

PIL-BRKT-ASSY-GR	1
RING20X3	1
CPLR-SET-GR	2
PFILL-GR	4

Maximum Piling Diameter 16 Inches
The design incorporates a replaceable wear ring and six pockets to adjust the bracket in 6.5" increments.



Anchoring: Stand Off Brackets

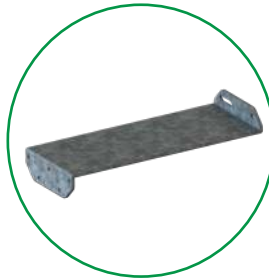

- or -

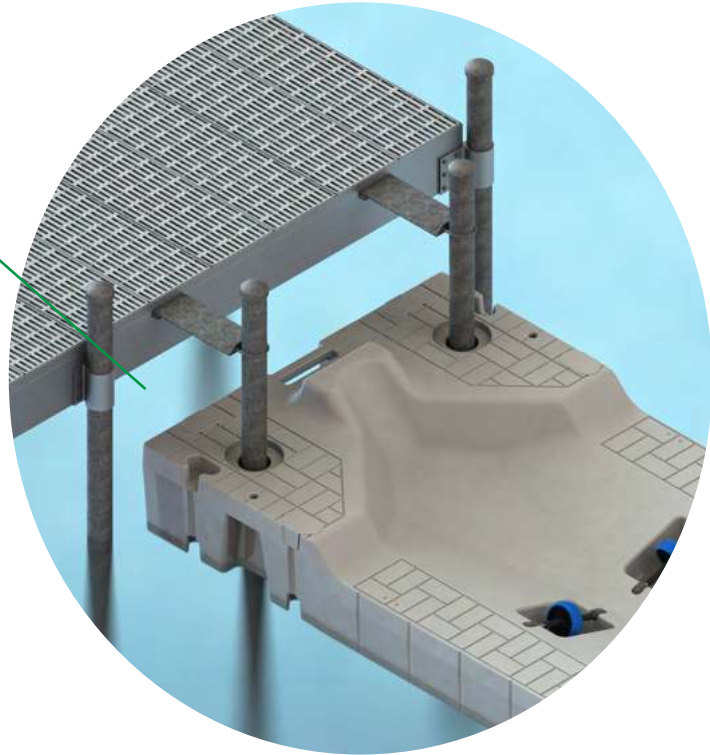

Stand Off Bracket:

SO BRKT 1

Fits up to 2" inch nominal pipe.
Actual Dimension is 2.5" inch OD.

"Z" Pipe Stand Off Bracket:

SO Z BRKT 1

** 5/16" Inch "U" Bolt 1*

** Lock Nut 2*

Screws up to a .25 inch can be
use to mount the "Z" Bracket.

Installation hardware is the responsibility of the buyer.



Anchoring: Deadweight Brackets

Male Half Coupler

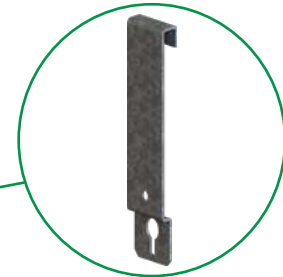
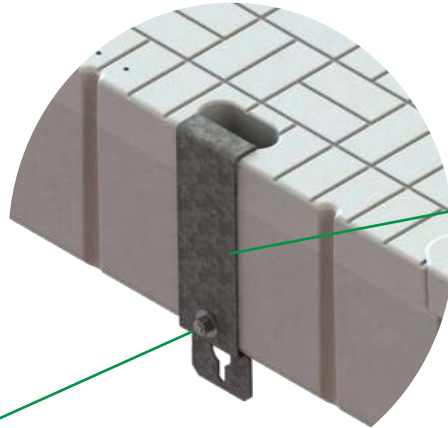

Standard Duty Galvanized
Deadweight Bracket

-or-

Female Half Coupler

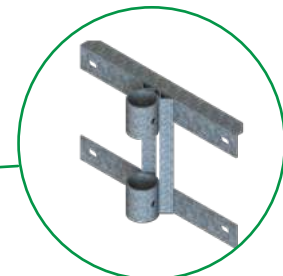
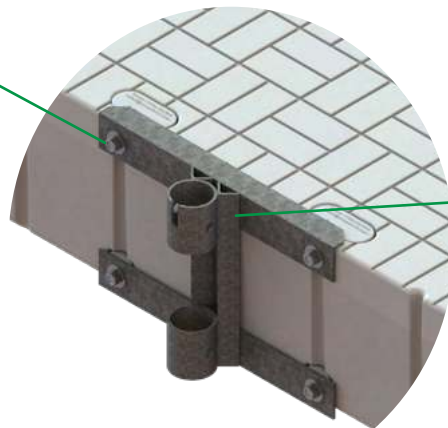

Heavy Duty Galvanized
Deadweight Bracket

Standard Duty Galvanized
Deadweight Bracket:

ANCR 1

Half Couplers Sold Separately

Heavy Duty Galvanized
Deadweight Bracket:

ANCR-PIPE 1

Half Couplers Sold Separately

Anchoring: Stiff Arm Assembly



Stiff Arm Adapter

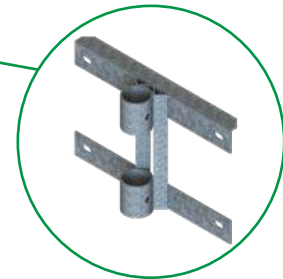
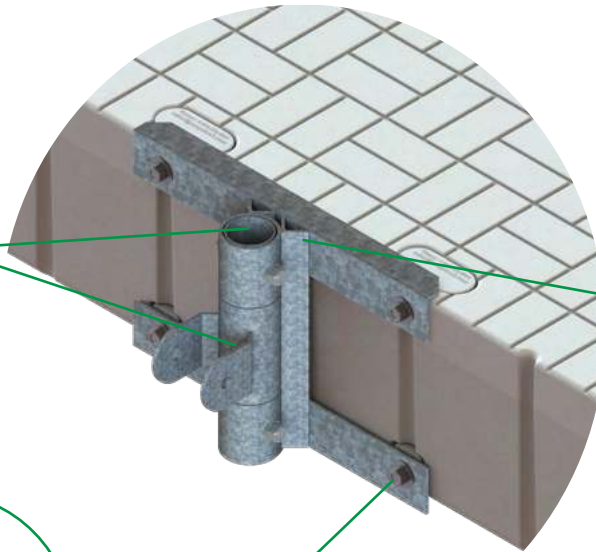

Heavy Duty Galvanized
Deadweight Bracket



Male Half Coupler

-or-



Female Half Coupler

Stiff Arm Assembly:

ANCR-PIPE	1
STIF-ADPT	1

Half Couplers Sold Separately

Stiff Arm Adapter:

STIF-ADPT	1
-----------	---

*Sold Separately:

- LOCKNUT-Z
- WASHER
- BOLT (McMaster # 92186A812)



Snap Dock Builder Tutorial

The Snap Dock Builder allows customers to configure their own dock layout which can then be shared with a dealer.

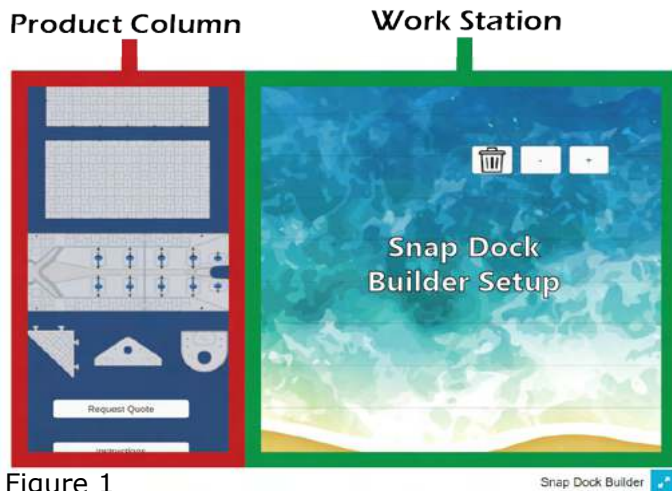

Figure 1 illustrates the initial screen an end user or dealer sees when clicking on the *Snap Dock Builder* Tab on our website.

The *Product Column* outlined in **RED** identifies Snap Dock Products that make up a draft of a dock layout.

The *Work Station* is outlined in **GREEN**, which identifies the area in which items will appear to construct a draft layout.

Figure 2 illustrates A 60" dock section that is selected to start a dock layout.

To choose a product, hover the mouse pointer over the desired item, then *single-click* to populate it into the workstation.

Note: Keep in mind that the number of times a product is selected will produce the same number of items into the workstation. If unwanted items populate, drag the item to the trash can to dispose of an object.

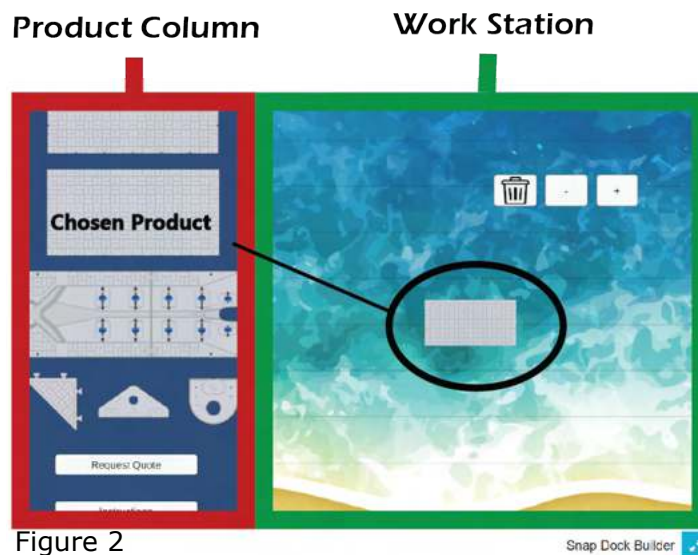

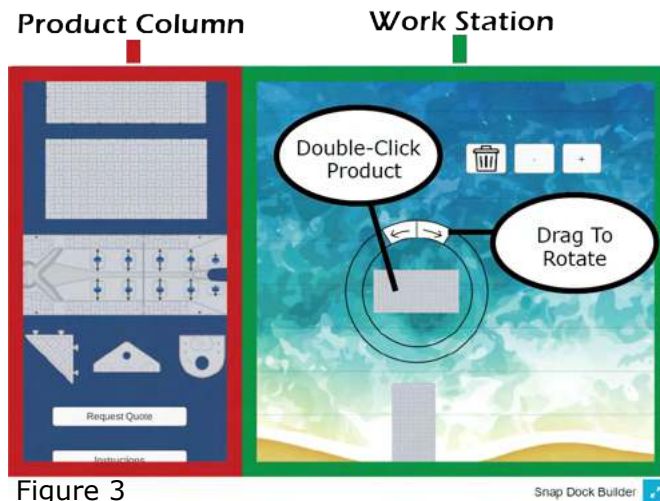

Figure 3

Figure 3 illustrates how to rotate a 60" component once it is into the workstation.

To rotate an object, the user needs to double-click directly on the product. The circular rotational tool will appear as two circles with opposite directional arrows. Use the cursor to click and drag the item in a circular motion for the preferred angle.

Figure 4 illustrates how a drafted layout will be presented using *Snap Dock Builder* application tool.

For end users, underneath the *Product Column* there is a *Request Quote* button that will send the complete drafted layout to the sales team to be sent to one of *Snap Dock's* dealers or distributors for quote.

For Dealers, create a screenshot of the Snap Dock Builder after a completed draft is done. This will create an image to share with the customer.

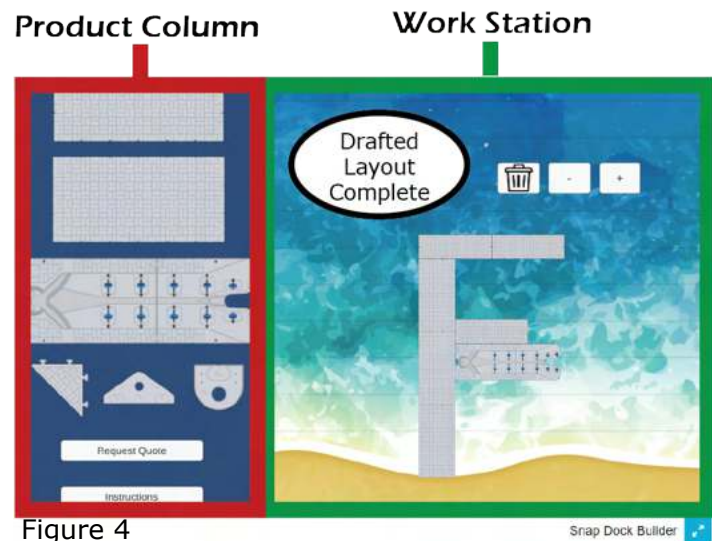
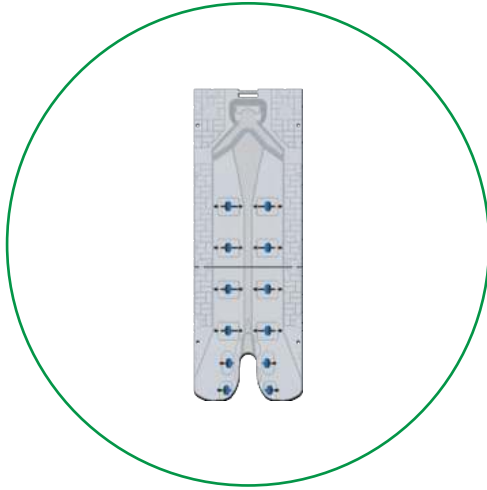

Figure 4

Snap Port Configurations



Single Port

Dimensions 168" x 59"
Bill of Materials 1 SNAP PORT-ASSY-GR

Double Port

Dimensions 168" x 118"
Bill of Materials 2 SNAP PORT-ASSY-GR
2 CPLR-SET-GR

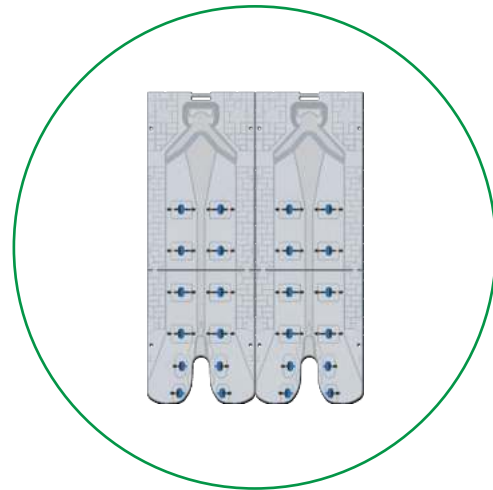

Triple Port

Dimensions 168" x 177"
Bill of Materials 3 SNAP PORT-ASSY-GR
4 CPLR-SET-GR

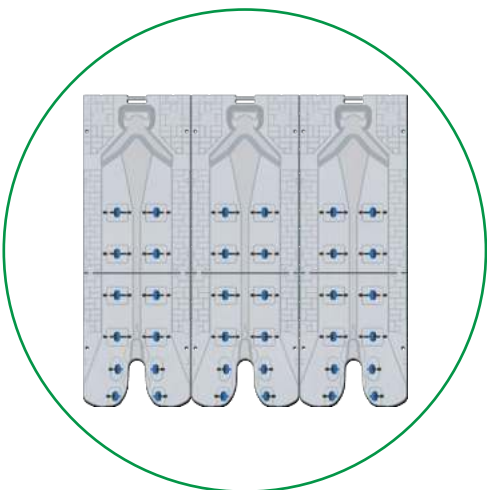

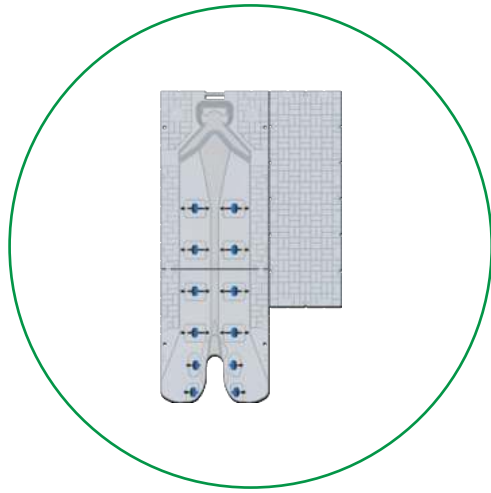

40" Section Layout A

Dimensions 168" x 98"

Bill of Materials
 1 SNAP PORT-ASSY-GR
 1 SNAP120x40-GR
 2 CPLR-SET-GR

40" Section Layout B

Dimensions 168" x 157"

Bill of Materials
 2 SNAP PORT-ASSY-GR
 1 SNAP120x40-GR
 4 CPLR-SET-GR

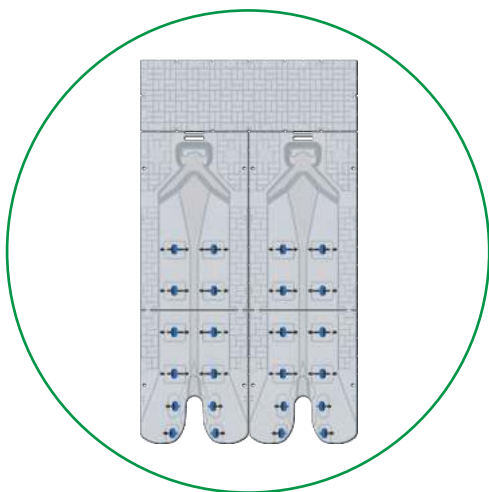
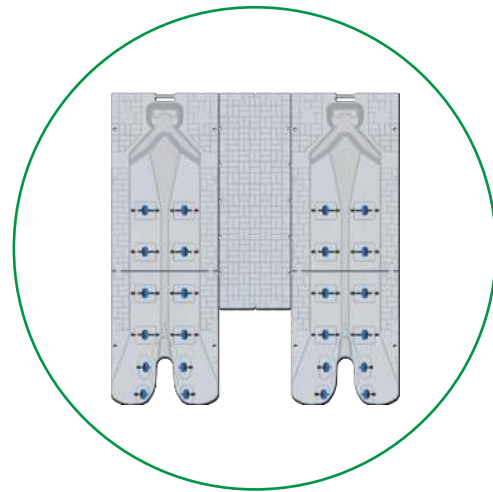

40" Section Layout C

Dimensions 207" x 117"

Bill of Materials
 2 SNAP PORT-ASSY-GR
 1 SNAP120x40-GR
 6 CPLR-SET-GR



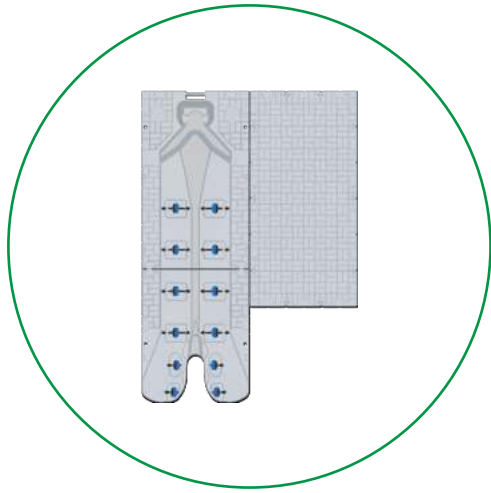

60" Section Layout D

Dimensions 168" x 157"

Bill of Materials
 1 SNAP PORT-ASSY-GR
 1 SNAP120x60-GR 2020
 2 CPLR-SET-GR

60" Section Layout E

Dimensions 168" x 117"

Bill of Materials
 2 SNAP PORT-ASSY-GR
 1 SNAP120x60-GR 2020
 4 CPLR-SET-GR

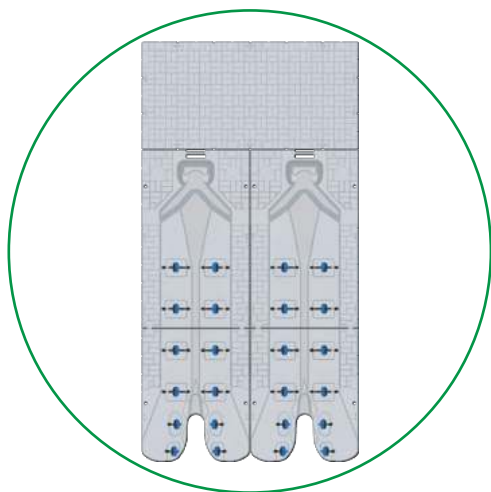
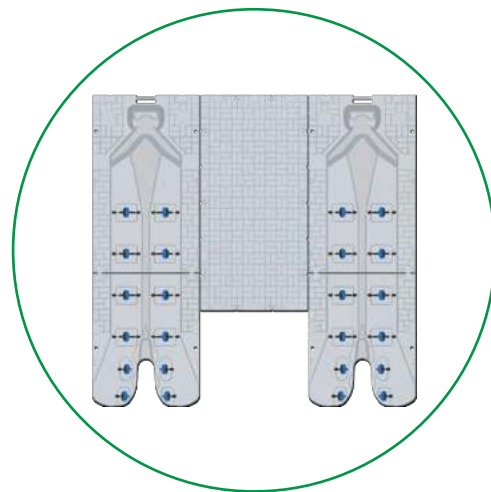

60" Section Layout F

Dimensions 227" x 117"

Bill of Materials
 2 SNAP PORT-ASSY-GR
 1 SNAP120x60-GR 2020
 6 CPLR-SET-GR



40" Dock Section Layouts

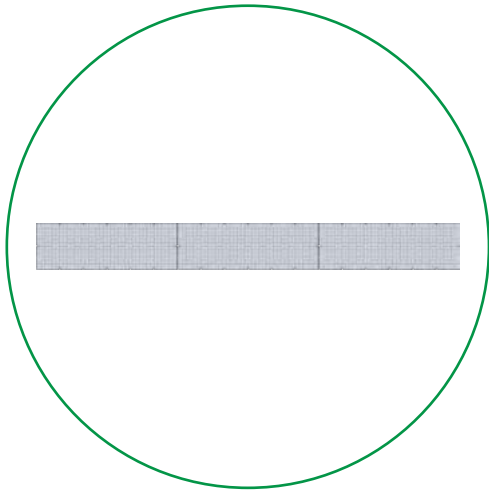

" I " Layout

Dimensions	351" x 39"
Bill of Materials	3 SNAP120x40-GR 4 CPLR-SET-GR

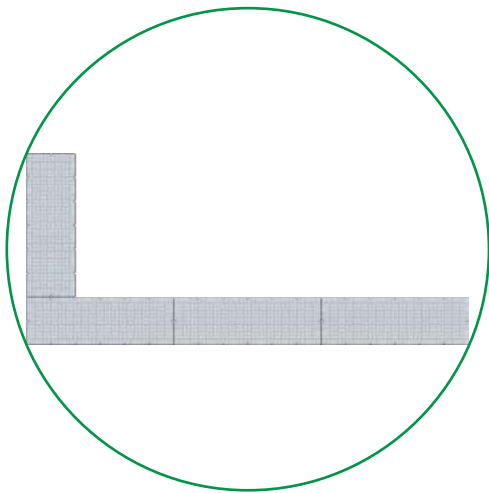

" L " Layout

Dimensions	351" x 156"
Bill of Materials	4 SNAP120x40-GR 6 CPLR-SET-GR



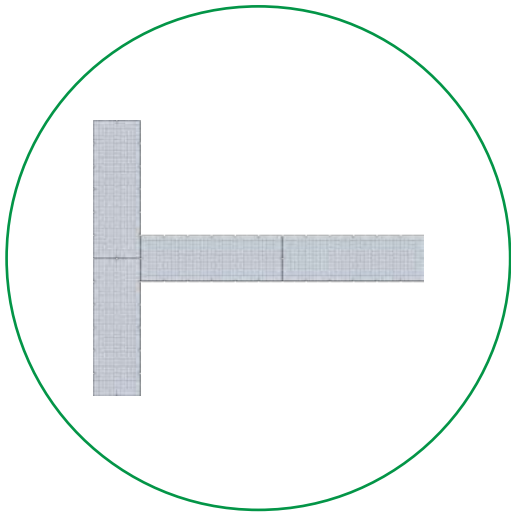

" T " Layout

Dimensions 273" x 234"
Bill of Materials 4 SNAP120x40-GR
6 CLPER-SET-GR

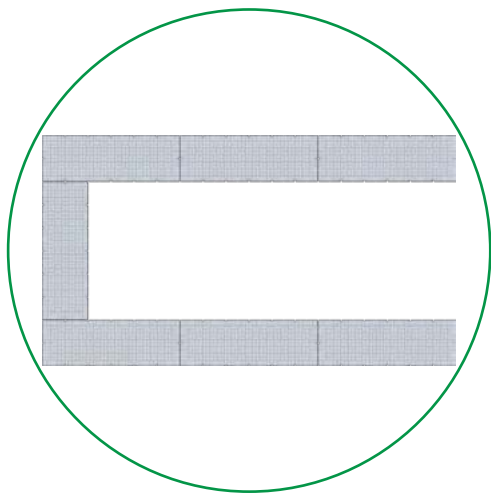

" U " Layout

Dimensions 351" x 195"
Bill of Materials 7 SNAP120x40-GR
12 CPLR-SET-GR



60" Dock Section Layouts

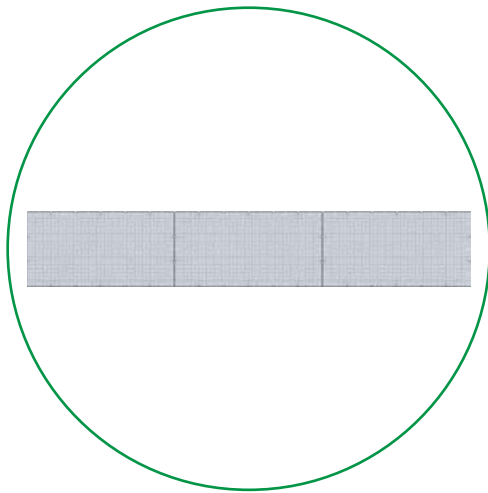

" I " Layout

Dimensions	351" x 59"
Bill of Materials	3 SNAP120x60-GR 2020 6 CPLR-SET-GR

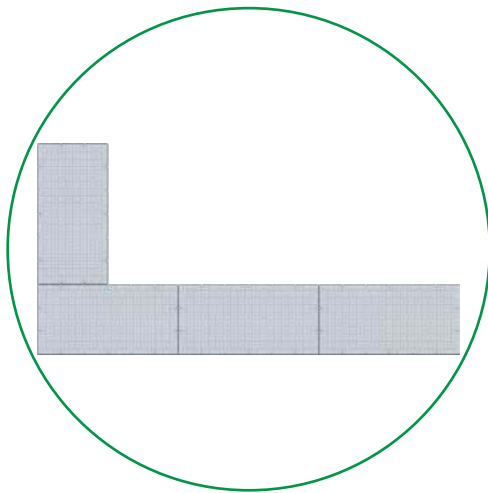

" L " Layout

Dimensions	351" x 176"
Bill of Materials	4 SNAP120x60-GR 2020 9 CPLR-SET-GR



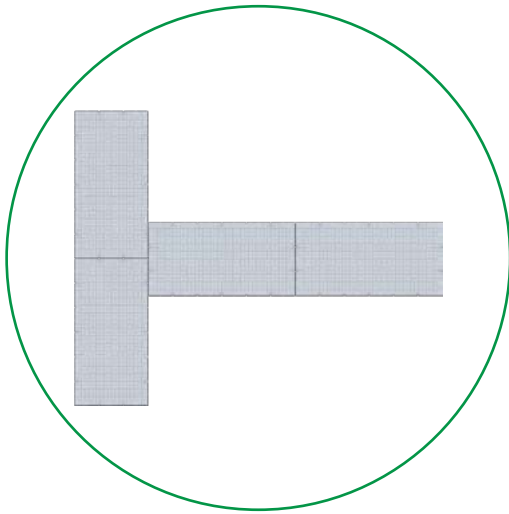

" T " Layout

Dimensions 351" x 293"
Bill of Materials 4 SNAP120x60-GR 2020
9 CLPER-SET-GR

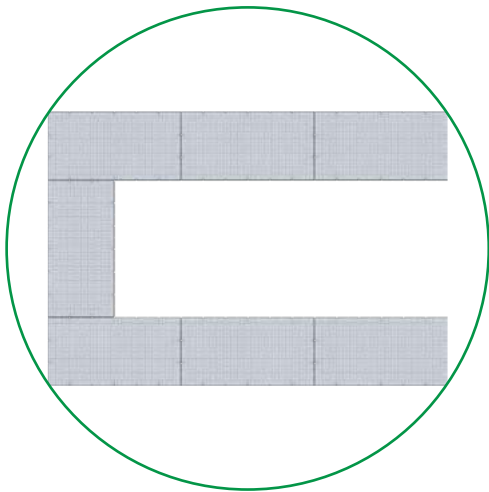

" U " Layout

Dimensions 351" x 235"
Bill of Materials 7 SNAP120x60-GR 2020
18 CPLR-SET-GR



40" & 60" Dock Section Layouts

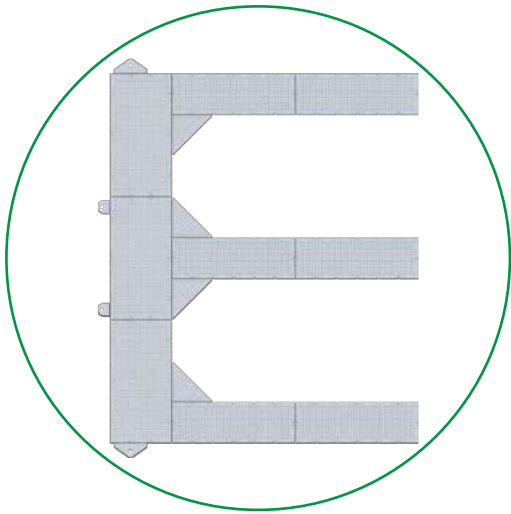

" M " Layout

Dimensions	351" x 293"
Bill of Materials	6 SNAP120x40-GR 3 SNAP120x60-GR 2020 18 CLPER-SET-GR 4 CORNER-GR-ASSY 2 STD-BRKT-GR-ASSY 2 HD-BRKT-GR-ASSY

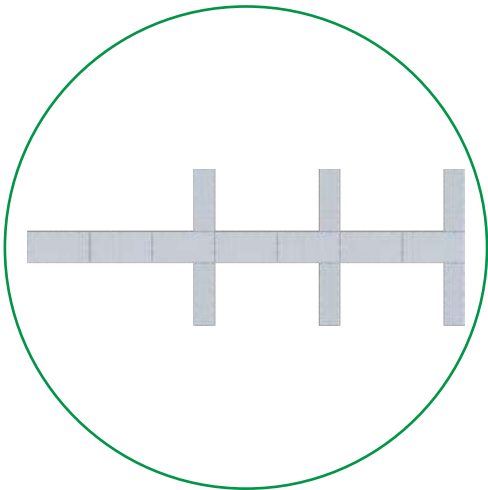

Triple " T " Layout

Dimensions	819" x 293"
Bill of Materials	6 SNAP120x40-GR 7 SNAP120x60-GR 2020 30 CPLR-SET-GR



Dock & Port Section Layouts

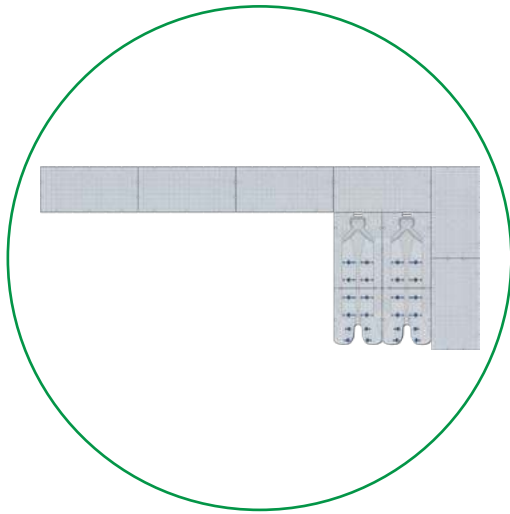

" L " Layout With Ports

Dimensions 527" x 234"

Bill of Materials
6 SNAP 20x60-GR 2020
2 SNAP PORT-ASSY-GR
21 CPLR-SET-GR

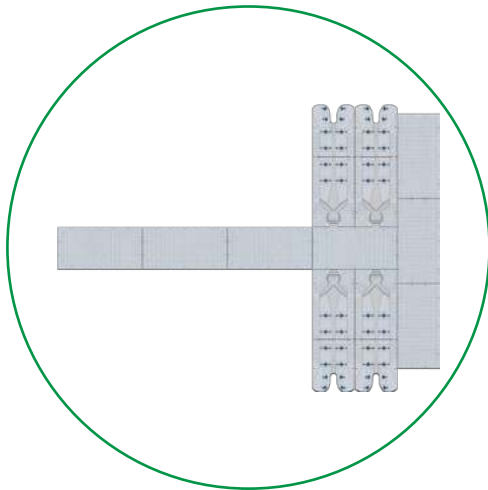

" T " Layout With Ports

Dimensions 527" x 395"

Bill of Materials
7 SNAP120x60-GR 2020
4 SNAP PORT-ASSY-GR
30 CPLR-SET-GR



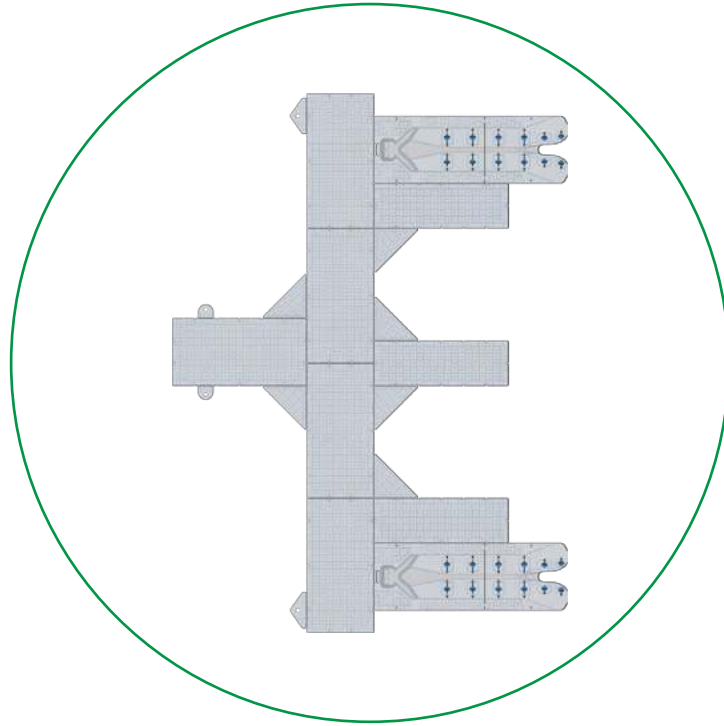

" M " Layout With Ports

Dimensions	344" x 468"
Bill of Materials	3 SNAP120x40-GR 5 SNAP120x60-GR 2020 2 SNAP PORT-ASSY-GR 26 CPLR-SET-GR 6 CORNER-GR 2 STD-BRKT-GR-ASSY 2 HD-BRKT-GR-ASSY



Polyethylene Products

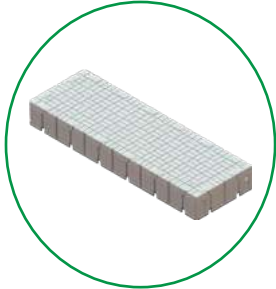

40" Dock Section

SKU: SNAP120x40-GR

Dimension: 117" x 39"

Description:
(1) 40" dock section (light gray) &
(12) pocket fillers.

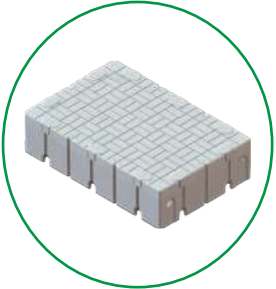

4060 Dock Section

SKU: SNAP60x40-GR

Dimension: 59" x 39"

Description
(1) 6040 dock section (light gray) &
(12) pocket fillers.

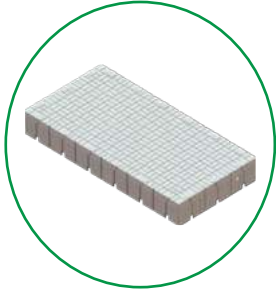

60" Dock Section

SKU: SNAP120x60-GR 2020

Dimension: 117" x 59"

Description:
(1) 60" dock section (light gray) &
(12) pocket fillers.

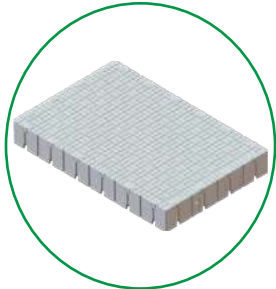

80" Dock Section

SKU: SNAP120X80-GR

Dimension: 117" x 79"

Description
(1) 80" dock section (light gray) &
(12) pocket fillers.

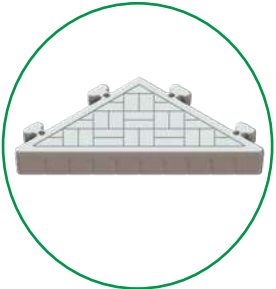

Corner Gusset

SKU: CORNER-GR-ASSY

Dimension: N/A

Description
(1) corner gusset (light gray) & (1)
corner gusset bolt kit.



Snap Port Assembly

SKU: SNAP PORT-ASSY-GR

Dimension: 168" x 59"

Description
(1) Snap Port Assembly (light gray).
See page 13 for specifications.





Port Entrance Assembly

SKU: PORT ENT-GR-ASSY

Dimension: 72" x 59"

Description

(1) port entrance (light gray) with (4) long port roller set, (4) short port roller sets, & (2) pocket fillers.



Port Front Assembly

SKU: PORT FRONT-GR-ASSY

Dimension: 96" x 59"

Description

(1) port front (light gray) with (4) long port roller set (1) port cover kit, & (6) pocket fillers.



Port Entrance

SKU: PORT ENT-GR

Dimension: 72" x 59"

Description

(1) port entrance (light gray).

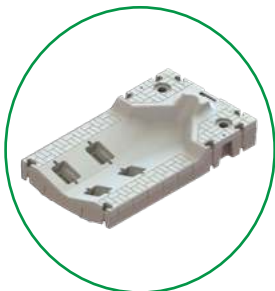

Port Front

SKU: PORT FRONT-GR

Dimension: 96" x 59"

Description

(1) port front (light gray).



Standard Duty Pipe Bracket

SKU: STD-BRKT-GR-ASSY

Dimension: N/A

Description

Includes: (1) standard duty pipe bracket (light gray) & (1) coupler set.



Heavy Duty Pipe Bracket

SKU: HD-BRKT-GR-ASSY

Dimension: N/A

Description

Includes: (1) heavy duty pipe bracket (light gray) & (2) coupler set.





Piling Bracket

SKU: PIL-BRKT-GR-ASSY

Dimension: N/A

Description

(1) piling bracket (light gray), (1) replaceable wear ring, (2) coupler sets, & (4) pocket fillers.



Wear Ring

SKU: RING20X3

Dimension: N/A

Description

(1) replaceable wear ring & 5/16" hardware.

Rubber & Nylon Products



Coupler Set

SKU: CPLR-SET-GR

Dimension: N/A

Description

(2) couplers (light gray) with (1) long bolt, (1) nut, & (1) drive tool.



Port Coupler Set

SKU: CPLR-PORT-GR

Dimension: N/A

Description

(2) couplers (light gray), (1) short bolt, (1) nut, & (1) drive tool.



Coupler

SKU: CPLR-GR

Dimension: N/A

Description

(1) coupler (light gray).



Coupler Bolt Kit

SKU: BOLT-KIT-GR

Dimension: N/A

Description

(1) long bolt (light gray), (1) nut, & (1) drive tool.



Port Coupler Bolt Kit

SKU: BOLT-S-KIT-GR

Dimension: N/A

Description

(2) port coupler bolt, (2) nuts, & (1) drive tool.

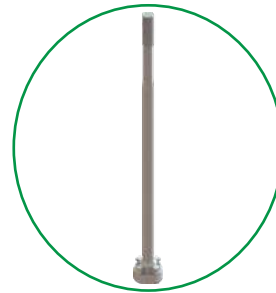

Coupler Long Bolt

SKU: BOLT-L-GR

Dimension: N/A

Description

(1) long bolt (light gray).





Port Coupler Short Bolt

SKU: BOLT-S-GR

Dimension: N/A

Description

(1) short bolt used for port couplers (light gray).



Nut

SKU: NUT-GR

Dimension: N/A

Description

(1) nut (light gray).



Drive Tool

SKU: DRIVETOOL

Dimension: N/A

Description

(1) drive tool (light gray).



Corner Gusset Bolt Kit

SKU: CBOLT-KIT-GR

Dimension: N/A

Description

(4) corner gusset bolts (light gray),
(4) nuts, and (1) drive tool.



Corner Gusset Bolt Kit

SKU: CBOLT-GR

Dimension: N/A

Description

(1) corner gusset bolt (light gray).



Female Half Coupler

SKU: HALFCPLR-F-GR-ASSY

Dimension: N/A

Description

(1) female half coupler (light gray)
with molded nut.





Male Half Coupler

SKU: HALFCPLR-GR-ASSY

Dimension: N/A

Description
(1) male half coupler (light gray)
with molded bolt and a nut.



Metal Products

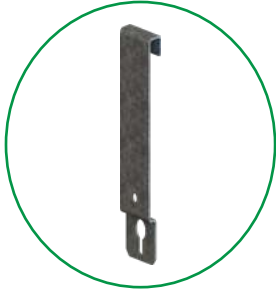

Standard Duty Galvanized
Deadweight Bracket

SKU: ANCR

Dimension: N/A

Description

(1) galvanized standard duty deadweight anchor bracket. Order with (1) HalfCPLR-GR.

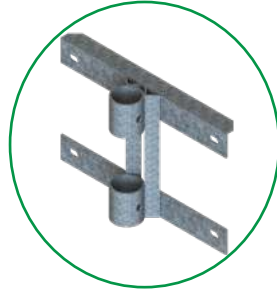

Heavy Duty Galvanized
Deadweight Bracket

SKU: ANCR-PIPE

Dimension: N/A

Description

(1) galvanized heavy duty deadweight & pipe bracket. Order with (4) HalfCPLR-GR.

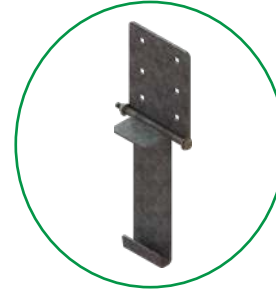

Galvanized Hinge Kit

SKU: HINGE-KIT-GALV

Dimension: N/A

Description

(1) galvanized hinge kit complete set of 2. Order with (2) HalfCPLR-GR.

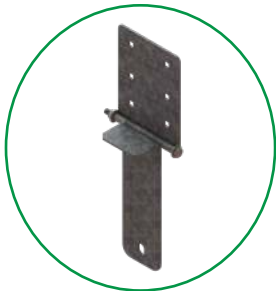

Universal Galvanized
Hinge Kit

SKU: HINGE-KIT-GALV-U

Dimension: N/A

Description

(1) galvanized hinge kit set of 2. Order with (4) HalfCPLR-GR.



Extended Galvanized
Hinge Kit

SKU: HINGE-KIT-GALV-XL

Dimension: N/A

Description

(2) extended galvanized hinge kit complete set of 2. Order with (2) HalfCPLR-GR



Stainless Steel Hinge Kit

SKU: HINGE-KIT-SS

Dimension: N/A

Description

(1) stainless steel hinge kit complete set of 2. Order with (2) HalfCPLR-GR.



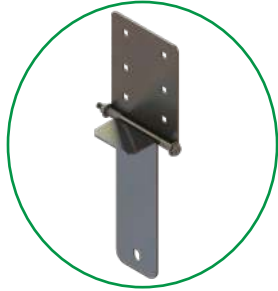

Universal Stainless Steel Hinge Kit

SKU: HINGE-KIT-SS-U

Dimension: N/A

Description

(1) stainless steel hinge kit complete set of 2. Order with (4) HalfCPLR-GR.

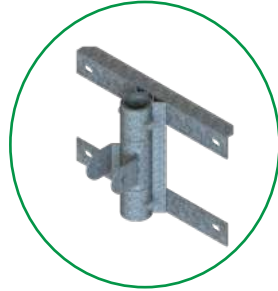

Stiff Arm Assembly

SKU: STIF-ASSY

Dimension: N/A

Description

(1) galvanneal heavy duty deadweight & pipe bracket & (1) stiff arm adapter. order with (4) HalfCPLR-GR.



Stiff Arm Adapter

SKU: STIF-ADPT

Dimension: N/A

Description

(1) galvanneal stiff arm insert, & (1) galvanneal support pipe insert.



Stand Off Bracket

SKU: SO BRKT

Dimension: N/A

Description

(1) galvanneal stand off bracket fitting 2" nominal OD or 2.5" actual pipe OD.



" Z " Pipe Stand Off Bracket

SKU: SO Z BRKT

Dimension: N/A

Description

(1) galvanneal "Z" stand off bracket.

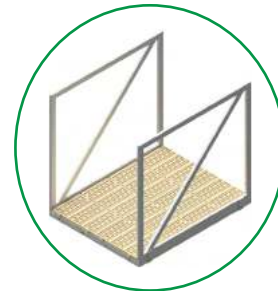

3' x 4' Residential Gangway

SKU: GWAY-R-3x4

Dimension: 3' X 4'

Description

(1) 3' x 4' residential gangway & composite decking unless aluminium is requested.

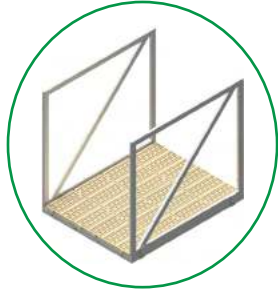

4' X 4' Residential Gangway

SKU: GWAY-R-4x4

Dimension: 4' x 4'

Description

(1) 4' x 4' residential gangway & composite decking unless aluminium is requested.



4' x 8' Ramp

SKU: RAMP-4x8

Dimension: 4' x 8'

Description

(1) 4' x 8' ramp & composite decking unless aluminium is requested.

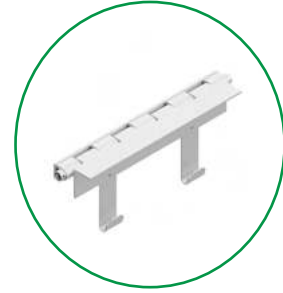

3' - 2-Pocket Bolt-On Hinge

SKU: GHINGE-2P3

Dimension: N/A

Description

2-pocket bolt-on dock hinge for 3' gangway or ramp.

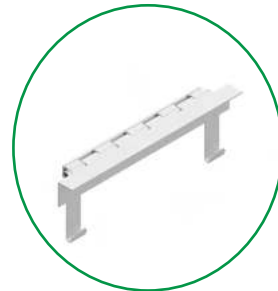

3' - 3-Pocket Bolt-On Hinge

SKU: GHINGE-3P3

Dimension: N/A

Description

3-pocket bolt-on dock hinge for 3' gangway or ramp.



4' - 3-Pocket Bolt-On Hinge

SKU: GHINGE-3P4

Dimension: N/A

Description

(1) 3-pocket bolt-on dock hinge for a 4' gangway or ramp.

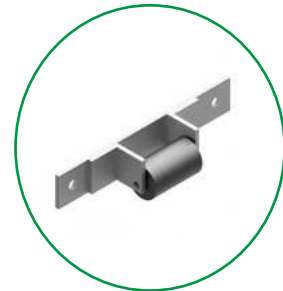

3' Roller Assembly

SKU: GROLLER-3

Dimension: N/A

Description

(1) 3' roller assembly for a gangway or ramp.



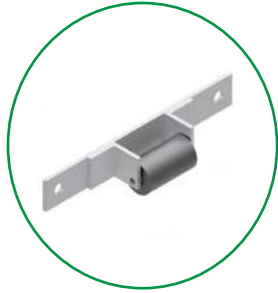

4' Roller Assembly

SKU: GROLLER-4

Dimension: N/A

Description

(1) 4' roller assembly for a gangway or ramp



3' Abutment Hinge

SKU: HINGE-A3

Dimension: N/A

Description

(1) 3' abutment hinge.



4' Abutment Hinge

SKU: HINGE-A4

Dimension: N/A

Description

(1) 4' abutment hinge.

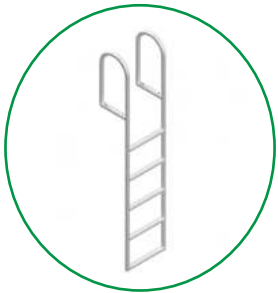

Fixed Ladder 5-Step

SKU: LADDER

Dimension: N/A

Description

(1) fixed five step ladder.



Swivel Ladder 5-Rung

SKU: LADDER-S

Dimension: N/A

Description

(1) swivel ladder five rung.



Dog Step Ladder

SKU: DSTEP

Dimension: N/A

Description

(1) dog step up ladder.



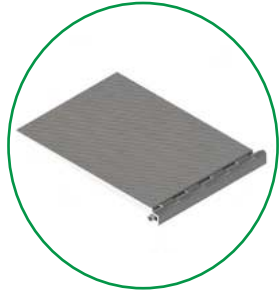

3' x 4' Transition Plate

SKU: T-PLATE-3x4

Dimension N/A

Description
(1) 3' x 4' transition plate.

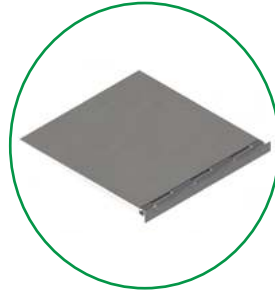

4' x 4' Transition Plate

SKU: T-PLATE-4x4

Dimension: N/A

Description
(1) 4' x 4' transition plate.

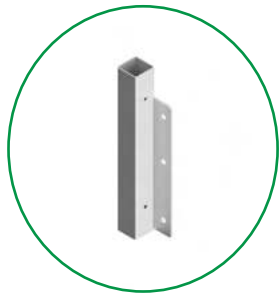

Umbrella Stand Sleeve

SKU: USTAND

Dimension: N/A

Description
(1) umbrella stand sleeve.

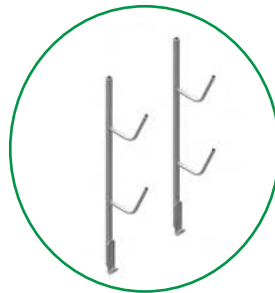

Kayak Rack

SKU: K-RACK

Dimension: N/A

Description
(1) kayak rack.

Port Accessories



Port Roller Long Set

SKU: ROLLER-L

Dimension: N/A

Description
includes (1) wheel, (5) spacers, (2) plugs, and (1) SBAR-15.



Port Roller Short Set

SKU: ROLLER-S

Dimension: N/A

Description
includes (1) wheel, (2) spacers, (1) plug, and (1) SBAR-8.



Port Spacer

SKU: SPACER

Dimension: N/A

Description
(1) black spacer.



Port Roller Wheel

SKU: WHEEL

Dimension: N/A

Description
(1) port wheel.



Port Roller Plug

SKU: PLUG

Dimension: N/A

Description
(1) light gray plug.



Long Stainless Steel Axis

SKU: SBAR-15

Dimension: N/A

Description
(1) stainless steel long axis for port roller long set.



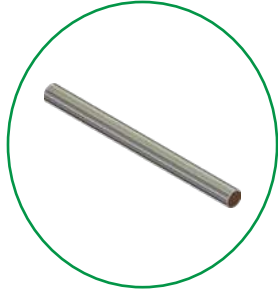

Short Stainless Steel Axis

SKU: SBAR-8

Dimension: N/A

Description

(1) stainless steel short axis for port rollershort set.

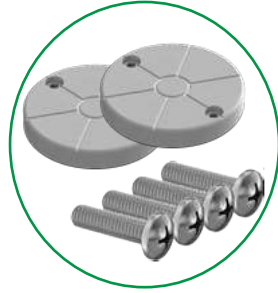

Port Cover Kit

SKU: PORT COVER-ASSY-GR

Dimensions: N/A

Description

(2) port Covers (light gray) and (4) 5/16"-18 stainless 1 1/4" screws.

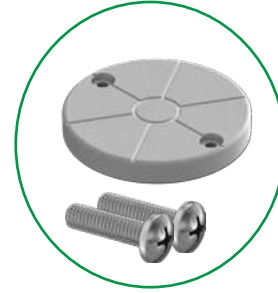

Port Cover

SKU: PORT COVER-GR

Dimensions: N/A

Description

(1) port Cover (light gray).

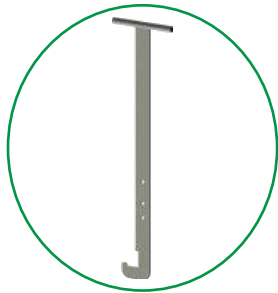

In Water Installation Tool

SKU: SNAP INSTALL

Dimensions: N/A

Description

(1) in water installation tool.



Pocket Filler

SKU: PFILL-GR

Dimension: N/A

Description

(1) pocket filler (light gray).



Breather Vent

SKU: VENT-GR

Dimension: N/A

Description

(1) m12x1.5 vent (light gray).



Add-On Accessories



8" Nylon Cleat

SKU: CLEAT-8-ASSY

Dimension: N/A

Description
(1) black 8" cleat & (2) 5/16" stainless screws.



Coupler Light

SKU: CPLR-LITE

Dimension: N/A

Description
order direct from [Lake Lite](#).

All Hardware Products



Cleat Screw

SKU: SCREW-CLT

Dimension: N/A

Description
(2) 5/16"-18 stainless 2"
screw for cleat.

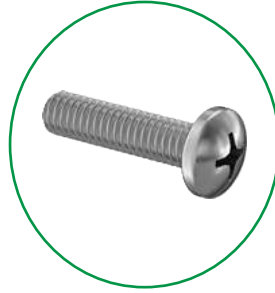

Port Cover Screw

SKU: SCREW-COV

Dimensions: N/A

Description
(2) 5/16"-18 stainless 1 1/4"
screw for port cover.

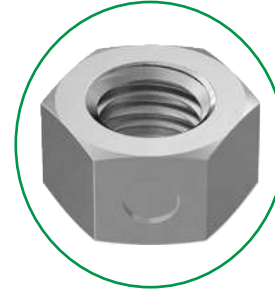

Zinc Locknut

SKU: LOCKNUT-Z

Dimension: N/A

Description
(1) 5/8"-11 thread size zinc
locknut.

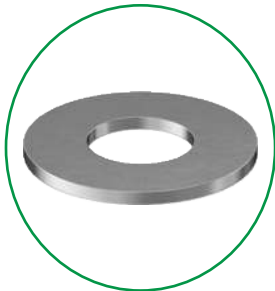

Stainless Steel Washer

SKU: WASHER

Dimension: N/A

Retail Price \$2.75

Description
(1) 18-8 stainless steel washer for
5/8" screw size, 0.688" ID 1 1/2"
OD.

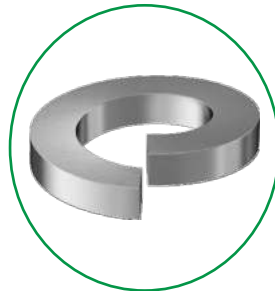

Stainless Steel Lock Washer

SKU: WASHERL

Dimension: N/A

Retail Price: \$2.75

Description
(1) 18-8 stainless steel lock washer
for 5/8" screw size,
0.688" ID 1 1/2" OD.

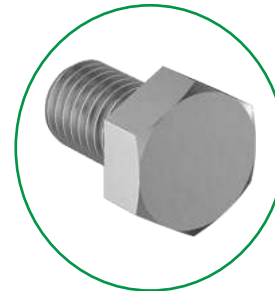

1" Inch Stainless Steel Bolt

SKU: BOLT-1

Dimension: N/A

Retail Price: \$4.25

Description
(1) 5/8"-11 stainless steel
bolt 1" length.



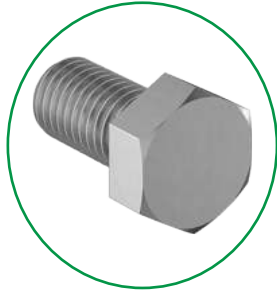

1.25" Inch Stainless Steel Bolt

SKU: BOLT-1.25

Dimension: N/A

Description
(1) 5/8"-11 stainless steel bolt 1 1/4" length.

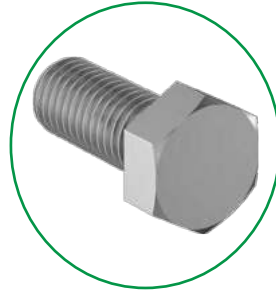

1.50" Inch Stainless Steel Bolt

SKU: BOLT-1.5

Dimension: N/A

Description
(1) 5/8"-11 stainless steel bolt 1 1/2" length.

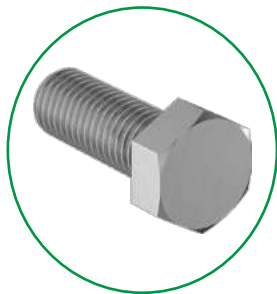

1.75" Inch Stainless Steel Bolt

SKU: BOLT-1.75

Dimension: N/A

Description
(1) 5/8"-11 stainless steel bolt 1 3/4" length.

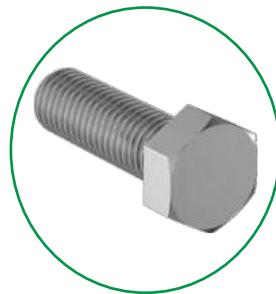

2" Inch Stainless Steel Bolt

SKU: BOLT-2

Dimension: N/A

Description
(1) 5/8"-11 stainless steel bolt 2" length.



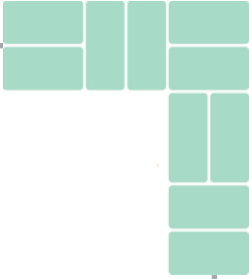
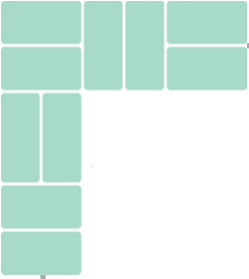

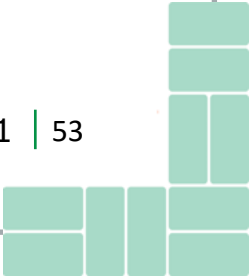
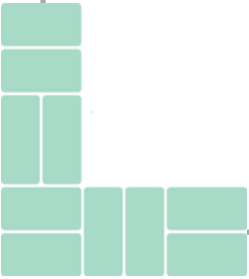



Credits: Canadadocks
Edited: Shane Pruitt



1-(800) 483-5205
sales@snapdock.com
snapdock.com

11405 N. Pennsylvania Street
Ste. 106
Carmel, IN, 46032